

Product

The **FluidInspectIR®_PLUS** offers real-time monitoring of oil condition in a compact system. This plug & play analyzer can be easily installed remotely in the oil circuit bypass line, allowing for sampling via an electric valve or with a pump from the oil tank/reservoir.

This innovative system is configurable and compatible with various types of fluids and lubricants including mineral, PAO, PAG, Phosphate Ester, Polyolester, and water-based emulsions. Users can expect to receive essential oil and fluid parameters with the same format, units, and accuracy found in standard oil analysis laboratory reports.



Summary Information

- MIR sensor to measure key parameters in oils and lubricants in gears, engines, turbines, hydraulic and transmission systems, metal working (see overleaf)
 - Correlates to ASTM / DIN
- Asset oil temperature up to 120C, higher optional
- Pump or electric valve integrated.
- Optional Viscosity sensor - KV40C/100C or flow sensor
- Error codes shown on display and sent directly via MODBUS or cloud communication.

Electrical / Mechanical Data

- Voltage: 100V to 240V AC or 24V DC
- Power: 120W Max
- Interfaces : Ethernet, RS485
- Dimensions/weight: 322W*232H*137D mm / 6kg
- Fluid Connections : G1/8 female thread for 6mm pipe (Hylok)

Key Benefits

- No need to use valuable human resources for oil sampling
- Reduction in Human–Machine interaction
- Data driven maintenance resulting in
 - Reduce unplanned downtime
 - Extended oil drain intervals
 - Reduction of CO2 footprint
 - Bottom line savings
- Support for warranty claims
- Enhanced data analytics to increase asset efficiency

Communication

- MODBUS (RTU, TCP), Profibus (available on request)
- Cloud integration via MQTT or Web API through provided modem or existing network
- Azure & AWS integration, others optional;
- Direct integration into on-site controllers



Applications and Measured Parameters

	Gas Engine (Landfill or LNG)	Turbomachinery	Hydraulic	Dielectric Oils	Gears and Rollers	Aluminium Rolling	Marine VLSFO / Diesel Engine	Diesel Engine	Marine Stern Tube / Thruster EAL	Metal-Working Fluids/Emulsions
Oxidation – abs/cm	✓	✓	✓	✓	✓		✓	✓	✓	
Nitration – abs/cm	✓									
Sulphation – abs/cm	✓						✓	✓		
ipH	✓									
Water – Low end (<1%)	✓	✓	✓	✓	✓		✓	✓	✓	
Water – Mid end (1-15%)					✓					
Water – High end (>15%)					✓					
Water/glycol %			✓							
TBN – mgKOH/g	✓						✓	✓		
TAN – mgKOH/g	✓	✓	✓	✓	✓		✓		✓	
KV100C – cSt (or mm/s ²)	✓						✓	✓	✓	
KV40C – cSt (or mm/s ²)		✓	✓	✓	✓	✓			✓	
Fuel Dilution							✓	✓		
Amine AO – %		✓								
Phenol AO – %		✓								
Mobil Wyrol 2,4,6,8 – wt%						✓				
Total Concentrate – m/m%										✓
Brix										✓
Specialist Additive Packages – m/m%										✓
Other additives upon request	✓	✓	✓	✓	✓	✓	✓	✓	✓	✓

- Repeatability: <+-5% of measured value
- Accuracy: <+-5% of measured value



Pin Assignment 5 pol RS485 M12

- M12 female for RS485 Modbus communication (unterminated)

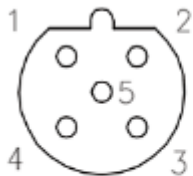

Pin assignment of the
Sensor connector

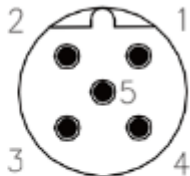

Pin assignment of the
Cable connector

Pin	Function
1	+5V DC
2	A
3	GND
4	B
5	Shield

Pin Assignment 2 pol 24V DC Version

- 2 pol LP-16 02 Series female connector.
- Cable provided with open endings (pig tails)

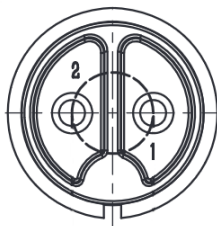

Pin assignment of the
Sensor connector

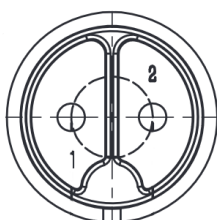

Pin assignment of the
Cable connector

Pin	Function
1	24V
2	GND

Pin Assignment 3 pol 100-230V Version

- 3 pol LP-16 02 Series female connector.
- Cable provided with open endings (pig tails)

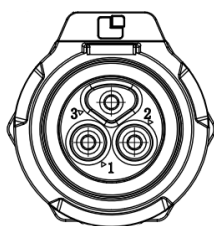

Pin assignment of the
Sensor connector

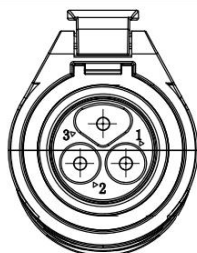

Pin assignment of the
Cable connector

Pin	Function
1	Live
2	Neutral
3	Earth





FluidInspectIR[®]

PLUS

Technical Drawings

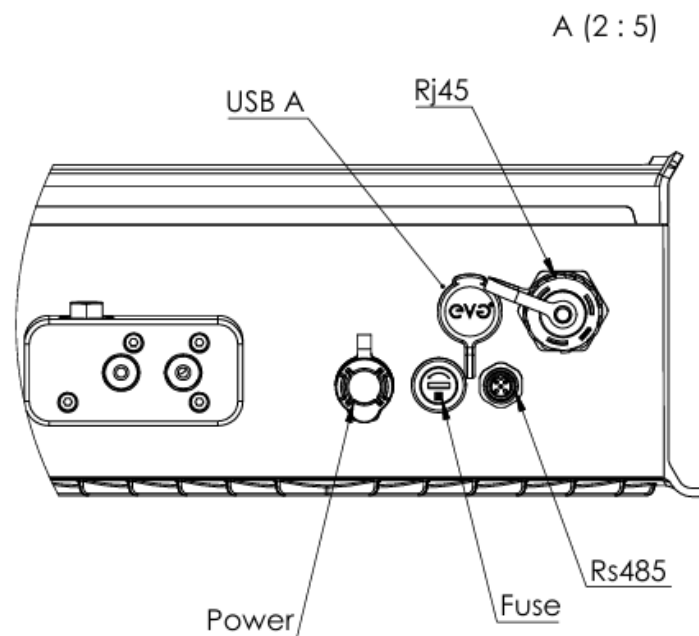
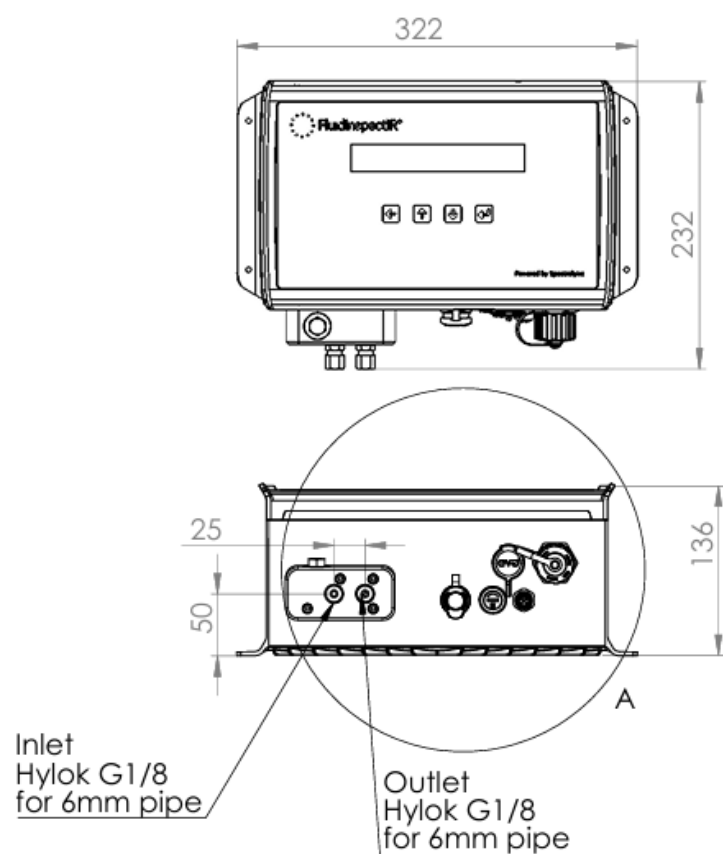

Spectrolytic
Innovative Solutions in Spectroscopy

Spectrolytic
info@spectrolytic.com
www.spectrolytic.com

Whilst the Company takes every precaution in the preparation of its catalogues, technical circulars, price lists and its other literature, these documents are for the Buyer's general guidance only and the particulars contained therein shall not constitute representations by the Company and the Company shall not be bound thereby.